

- Opción para Vidrio Simple o Laminado

B-B Corte Vertical

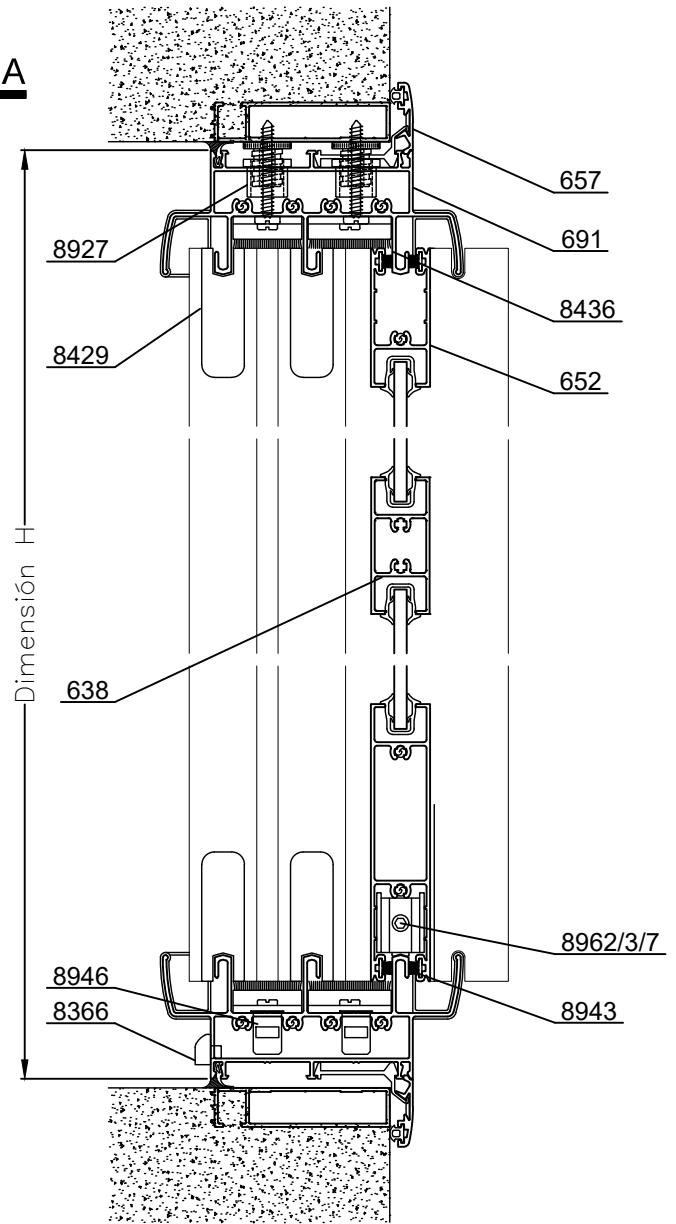

A-A Corte Horizontal

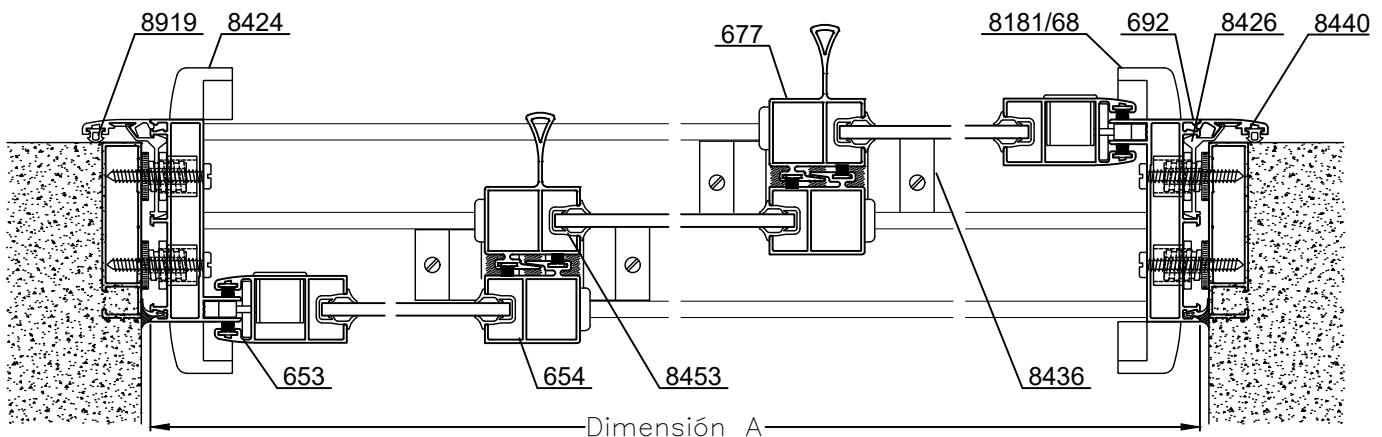







Escala 1:3

Tolerancia en Peso +/- 10% Tolerancia largo +10 mm -0 mm



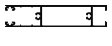









27-04-20 DELTA.47

- Opción para Vidrio Simple o Laminado

Dimensiones de Corte Ventana y Puerta Corrediza 3 Hojas				Ventana Corrediza			Puerta Corrediza		
Función	Código	Peso kg/m	Forma	Cant.	Largo	Corte	Cant.	Largo	Corte
Umbral y Dintel	691	1,83		2	A-42	90° 90°	2	A-42	90° 90°
Jamba	655	0,59		2	H	90° 90°	2	H	90° 90°
Parante Lateral	653	0,64		2	H-79	90° 90°	2	H-79	90° 90°
Parante Central	654	0,58		4	H-79	90° 90°	2	H-79	90° 90°
Par. Central con Tirador	677	0,79		-	-	-	2	H-79	90° 90°
Zócalo	652	0,64		4	A/3-7	90° 90°	2	A/3-7	90° 90°
				2	A/3+1		1	A/3+1	
Zócalo Alto	660	1,26		-	-	-	2	A/3-7	90° 90°
				-	-		1	A/3+1	
Travesaño	638	0,70		-	A/3-50 A/3+44	90° 90°	-	A/3-50 A/3+44	90° 90°

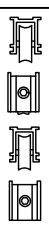
- Medidas en milímetros

- Dimensiones de Corte de Premarco y Contramarco, en página 55

Detalle de Accesorios Ventana y Puerta Corrediza 3 Hojas			Ventana	Puerta
Código	Descripción	Forma	Cantidad	Cantidad
8362	Tornillo Parker 10 x 1½ T-1		28 Unidades	34 Unidades
8453	Burlete en "U" para Vidrio B-60		2A + 6H	
8424	Tope Canal de Condensación T-91		4 Unidades	
8943	Felpa de 7x6 con Fin Seal		4A + 8H	
8181	Cierre Lateral Milano H-56 sin Kit		2 Unidades	
8168	Kit Delta p/cierre Lateral Milano			
8428	Tope Parante Lateral T-89		4 Unidades	
8429	Tope Parante Central T-90		8 Unidades	
8427	Rueda Ibiza Doble Regulable R-40 - 40 kg.		6 Unidades	
8430	Rueda Monza R-39			
8435	Rueda Imola R-39			
8437	Rueda Imola Simple R-41			
8441	Rueda Regulable R-42 - 40 kg.			
8445	Rueda Ibiza Doble R-42			
8454	Rueda Ibiza Simple R-40 - 20 kg.			
8436	Cruce Central de Hoja T-93		4 Unidades	
8946	Boca Desagüe T-94		s/m	
8366	Tapa Desagüe T-69		2 Unidades	
8416	Junta de Estanqueidad T-101		4 Unidades	

- Detalle de Accesorios para Fijación y Contramarco en página 55

- s/m : según medida

Tolerancia en Peso +/- 10% Tolerancia largo +10 mm -0 mm

27-04-20 DELTA.48